



# RELIABLE HARD GLASS BEAM POWER AMPLIFIER FOR PULSE AND HIGH VOLTAGE REGULATOR SERVICE

## DESCRIPTION

One of the Bendix line of  tubes, this high-perveance beam power amplifier has been designed for use in aircraft, military and industrial applications where freedom from early failures, long average service life and uniform operating characteristics are extremely important. Each tube is given a 45-hour run-in under overload. This run-in serves to reduce early failures that might lead to failure under operating conditions. These tubes are also conditioned to operate in high voltage circuits such as high-voltage regulators, and pulse applications.

Since this tube is designed for use in equipment with high ambient temperatures and where high levels of vibration and shock are encountered, special materials and techniques are employed. The hard glass bulb and tungsten stem seal construction are features similar to those found on many high-powered transmitting tubes. Careful exhaust to a high degree of vacuum, with thorough outgassing of all elements by means of electron bombardment, as well as the usual RF induction heating, insures maximum life expectancy. These factors, as well as a conservative design center of cathode temperature, permit operation of the 6889 at bulb temperatures up to 300°C. Moreover, because of the lower expansion of the hard glass bulb (about 1/3 that of conventional receiving tube "soft glass"), greater resistance to thermal shock is attained.

The use of more refractory materials such as ceramics and hard glass, together with proper material treatment and high vacuum exhausting, provides a tube free from transient outgassing and contaminants likely to cause difficulty at high voltages in applications subject to unusual shock and vibration environments.

### CHART 1. ELECTRICAL RATINGS\*

Heater Voltage (AC or DC).....	6.3 volts
Heater Current .....	1.20 amps
Plate Voltage (Max DC).....	3000 volts
Screen Voltage (Max DC).....	850 volts
Plate Dissipation (Absolute Max).....	30 watts
Screen Dissipation (Absolute Max).....	3.5 watts
Cathode Current (Max DC Value).....	125 mA
Cathode Current (Max Inst. Peak value—of continuous sine wave).....	250 mA
Cathode Current (Max Inst. Peak Value) Pulse***.....	4.5 amps
Heater-Cathode Voltage (Max).....	±450 volts
Grid Resistance (Max).....	0.1 megohm
Grid Voltage (Max DC).....	+5.0 volts
(Min DC).....	-200 volts
(Max Inst. Peak Value) Pulse***.....	+220 volts
Cathode Warm-up Time.....	45 seconds

\*To obtain greatest life expectancy from tube, avoid designs where the tube is subjected to all maximum ratings simultaneously. See application notes.

\*\*Voltage should not fluctuate more than ±5%.

\*\*\*See pulse rating chart.

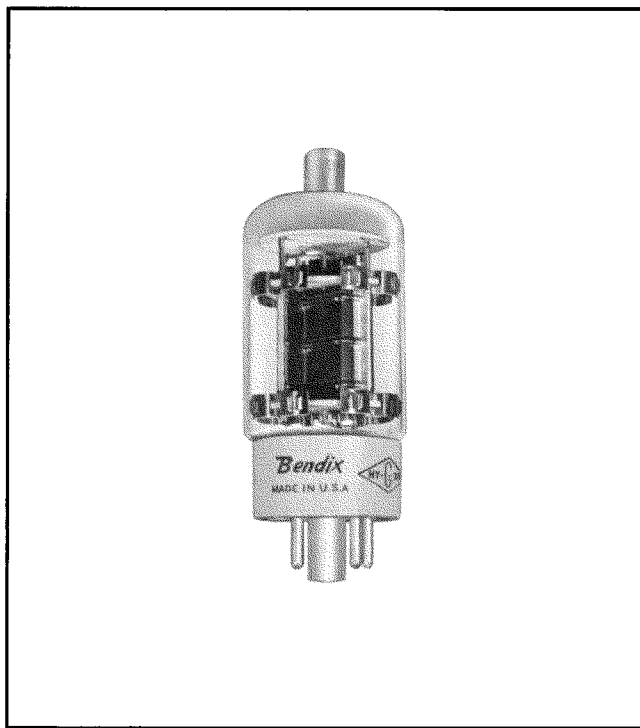

Other special features include a rugged, pure tungsten, helical heater which is used with a high purity aluminum oxide insulator, enabling reliable operation at high heater-cathode voltages. Also featured is a ceramic shield which prevents getter flash from forming inter-electrode leakage paths.

The design of this tube is a result of extensive engineering evaluation on special impact vibration equipment in which the accelerations equal or exceed those encountered in severe aircraft applications. The shake table used for these studies shock excites the tubes at a repetition rate of 15 cycles per second with a minimum peak acceleration of 50G. These tests indicate that the Bendix 6889 will survive thousands of hours longer, under extremely adverse conditions.

### CHART 2. MECHANICAL DATA

Base .....	Intermediate (short) Shell Octal (6-pin) (Glass filled Mica)
Bulb .....	Nonex Glass—T-11
Max Overall Length.....	3-29/32"
Max Seated Height.....	3-3/8"
Max Diameter .....	1-7/16"
Mounting Position .....	Any
Max Altitude .....	80,000 feet
Max Bulb Temperature.....	300°C
Max Impact Shock.....	500G
Max Vibration Acceleration.....	50G
	(100-hour shock excited fatigue test, sample basis)
Life Expectancy .....	10,000 hours

THE **Bendix** CORPORATION

*Red Bank* DIVISION, EATONTOWN, NEW JERSEY

## ELECTRICAL CHARACTERISTICS AND ENVIRONMENTAL TESTS

### CHARACTERISTIC TESTS

CHART 3.

CHARACTERISTIC	SYMBOL	MIN	DESIGN CENTER	MAX	UNITS
<b>PRODUCTION TESTS</b>					
Short and Continuity					
Heater Current	I <sub>f</sub>	1.12	1.20	1.28	A
Heater Cathode Leakage (E <sub>hk</sub> = ± 450 Vdc)	I <sub>hk</sub>	—	—	50	μAdc
Grid Current	I <sub>c1</sub>	—	—	-0.5	μAdc
Plate Current	I <sub>b</sub>	60	77	94	mAdc
Screen Grid Current	I <sub>c2</sub>	0.5	3.5	6.5	mAdc
Transconductance (1)	S <sub>m</sub>	4500	5400	6300	μmhos
Cut off Plate Current (E <sub>c1</sub> = -185, E <sub>b</sub> = 3000)	I <sub>b</sub>	—	—	1.0	mAdc
<b>DESIGN TESTS</b>					
Transconductance (2) (E <sub>f</sub> = 5.7 V)	ΔS <sub>m</sub>	—	—	10%	
Accelerated Grid Current (E <sub>f</sub> = 7.0 V)	I <sub>c1</sub>	—	—	-1.0	μAdc
Pulsed Operation	i <sub>b</sub>	4.0	—	—	a
<b>ELECTRODE</b>	E <sub>f</sub>	E <sub>b</sub>	E <sub>c2</sub>	E <sub>c1</sub>	E <sub>hk</sub>
<b>TEST CONDITIONS</b>	6.3 volts	250 Vdc	250 Vdc	-22.5 Vdc	0 Vdc
<b>PULSE TEST CONDITIONS</b>	6.3 volts	1200 Vdc	750 Vdc	-200 Vdc	0 Vdc

### ENVIRONMENTAL TESTS

CHART 4.

TEST	CONDITIONS	DURATION
Heater Cycling Life Test	On 1 Min Off 4 Min E <sub>f</sub> = 7.0 E <sub>hk</sub> = 300	2,000 On-Off Cycles
Survival Rate Life Test	Under "Test Conditions" at 30 W Plate Dis.	100 Hours
Pulse Life Test	i <sub>b</sub> = 4.0 A	500 Hours
Life "Expectancy" Test	Under "Test Conditions"	10,000 Hours
High Level Fatigue Test	50G—Shock Excitation 15 Cycles/Sec.	100 Hours
Shock	500 G	20 Impacts
Altitude Test	80,000 Feet	5 Minutes
Glass Strain Test	Boiling Water to Ice Water	3 Minutes in Each
Swept Freq Fatigue	5G—F = 50—500 CPS	96 Hours

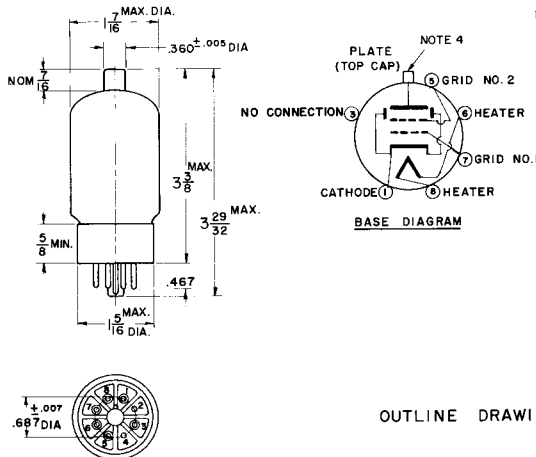

NOTES:

- ALL DIMENSIONS ARE IN INCHES UNLESS OTHERWISE SPECIFIED.
- SHORT INTERMEDIATE SHELL OCTAL 6-PIN BASE.
- NUMBERS ARE FOR REFERENCE ONLY AND DO NOT APPEAR ON BASE.
- CAP: SMALL C1-1

OUTLINE DRAWING

CHART 5.

AVERAGE PLATE CHARACTERISTICS

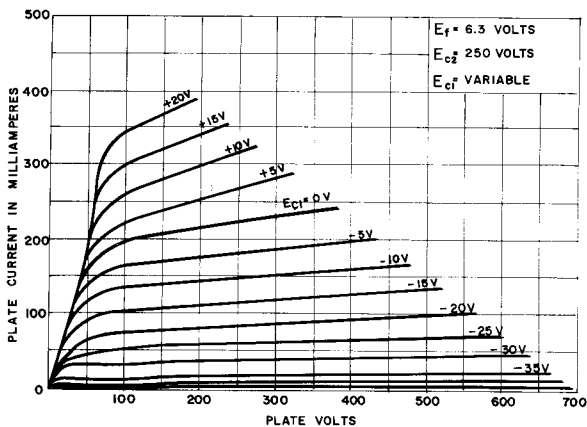
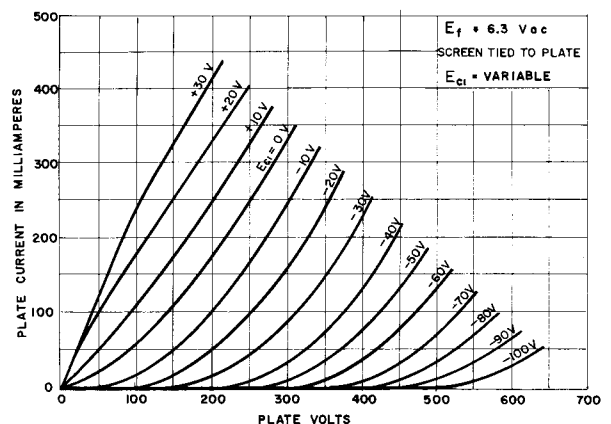

CHART 6.

TYPICAL TRIODE CHARACTERISTICS





**ADDITIONAL PENTODE  
CHARACTERISTICS**

**PULSE CHARACTERISTICS**

See CHART 13 page 4 (Pulse Ratings)

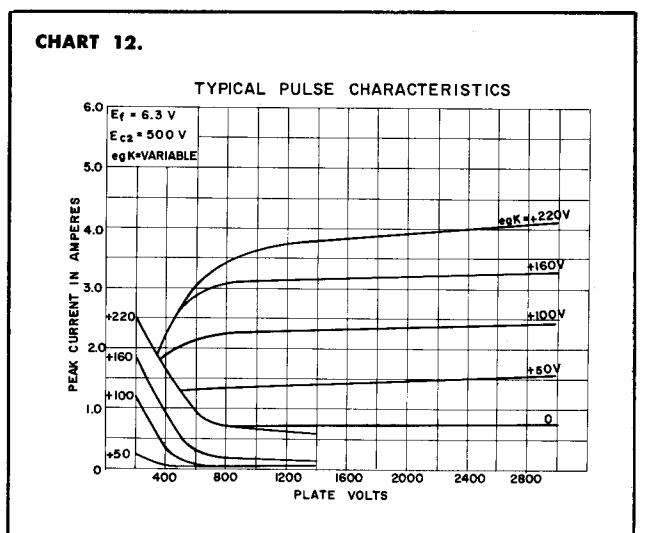
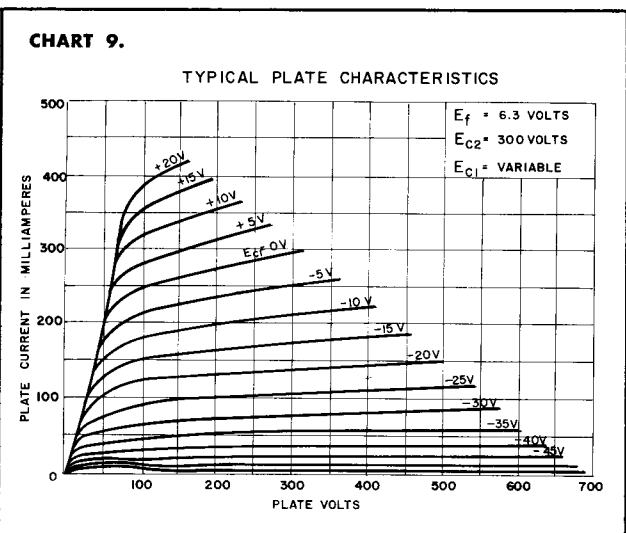
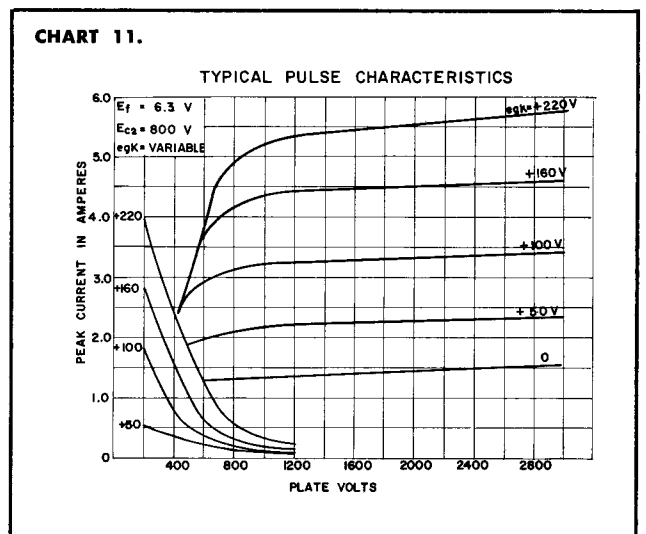
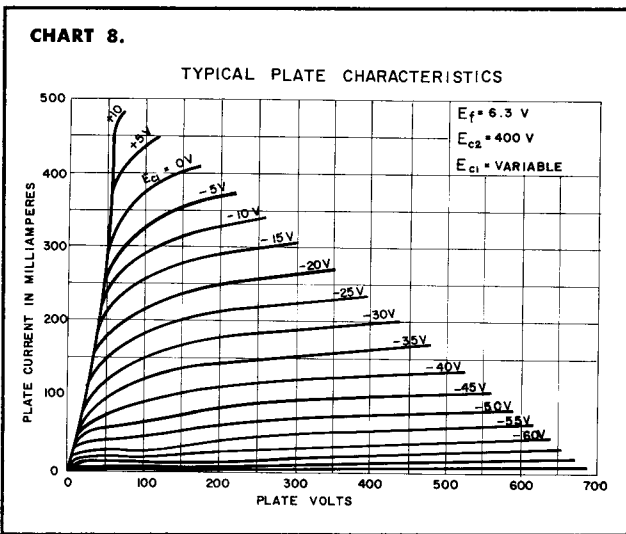
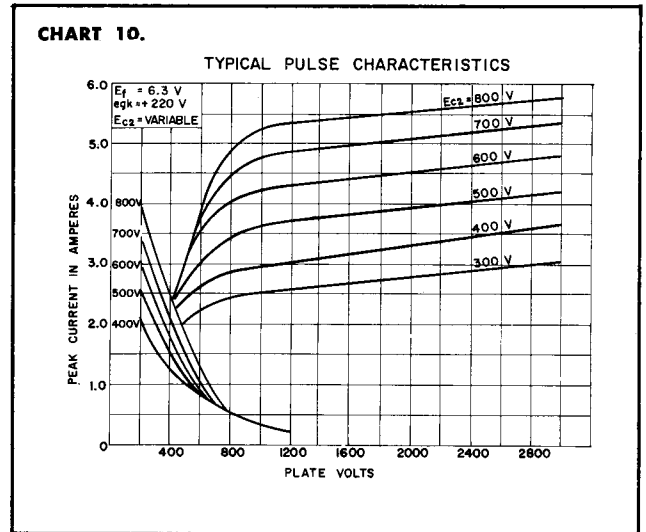
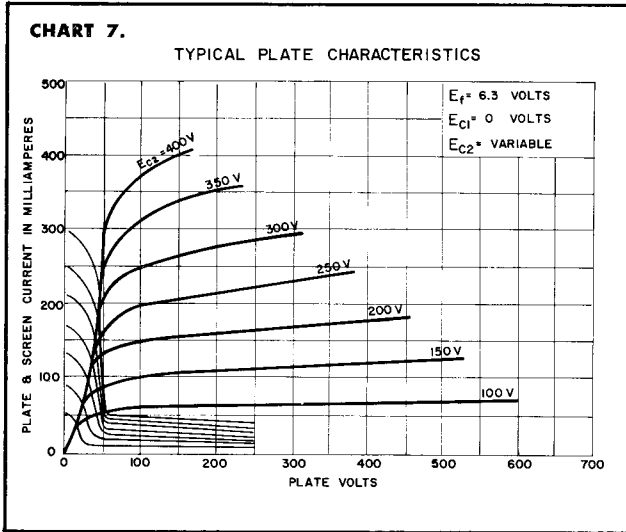

# BEAM POWER AMPLIFIER (PULSE)

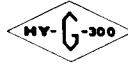

**6889**  
*Bendix* Type TE-52

**CHART 13. PULSE RATING**

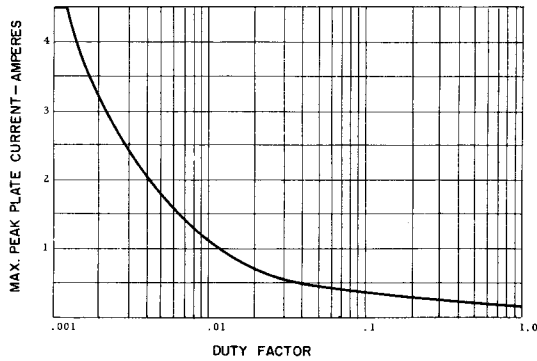

Duty factor (10,000 microsecond averaging time) for the 6889 is defined as the ratio of "ON" time in microseconds to 10,000 microseconds.

"ON" TIME is defined as the sum of the duration of all individual pulses which occur during any 10,000 microsecond interval.

**CHART 14. PULSE TEST CIRCUIT**

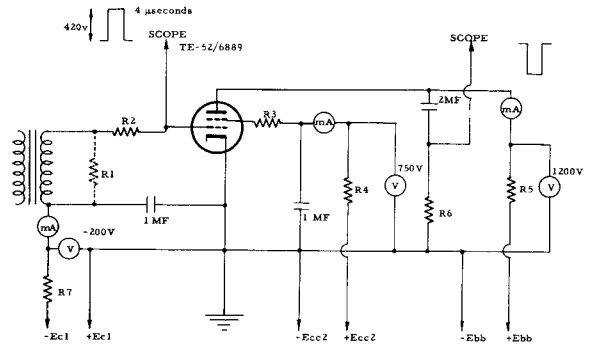

- R1=Adjust for minimum ringing and overshoot.
  - R2=12Ω (approximately), 1 watt (Parasitic suppressor).
  - R3=12Ω (approximately), 1 watt (Parasitic suppressor)
  - R4=1500Ω 100 watt wire wound.
  - R5=1500Ω 100 watt wire wound.
  - R6=2Ω, 1/2%, 10 watts, carbon.
  - R7=150Ω, 10 watts
- SCOPE = TEKTRONIX TYPE 535 OR EQUIVALENT

## APPLICATION NOTES

Special attention should be given to the temperatures at which the tubes are to be operated. Reliability will be seriously impaired if maximum bulb temperature is exceeded. The life expectancy will be reduced if conditions other than those specified for life test are imposed on the tube and will be reduced appreciably if absolute maximum ratings are exceeded. Both reliability and performance will be jeopardized if filament voltage ratings are exceeded. Life and reliability of performance are directly related to the degree that regulation of the heater voltage is maintained at its center rated value.

This tube is constructed using nonex glass and thus can withstand higher ambient temperatures in operation. However, the bulb temperature should never exceed 300°C at its hottest point and cooling should be employed if necessitated by the additive effects of operation at high altitudes and high dissipation simultaneously or by other sources of heat in the equipment.

The plate voltage rating and high-perveance of the 6889 make it readily adaptable to varied pulse applications. In order to insure maximum reliability in pulse service the peak plate current should not exceed the value shown in Chart 13 for the required duty factor.

## CUT-OFF CHARACTERISTICS

For  $I_b = 1.0 \text{ ma}$

**CHART 15.**

TYPICAL CURRENT CUT-OFF CHARACTERISTICS

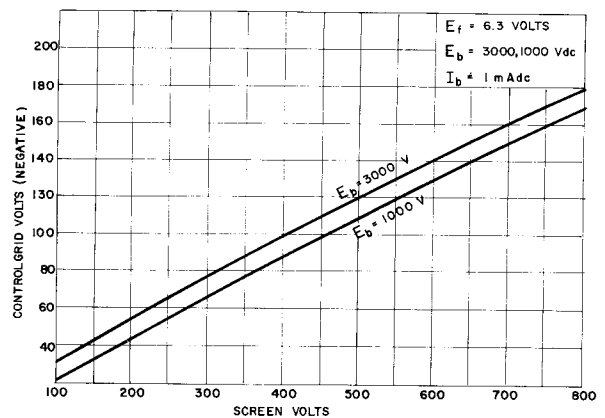

**THE Bendix CORPORATION**

*Red Bank* DIVISION, EATONTOWN, NEW JERSEY

West Coast Sales & Service: 117 E. Providencia Ave., Burbank, Calif.

Export Sales & Service: Bendix International Division,  
205 E. 42nd St., New York 17, N.Y.

Canadian Distributor: Computing Devices of Canada, Ltd., P.O. Box 508,  
Ottawa 4, Ontario