

Beam Power Tube

FORCED-AIR COOLED

CERAMIC-METAL SEALS
 COAXIAL-ELECTRODE STRUCTURE
 UNIPOTENTIAL CATHODE

170 WATTS PEP OUTPUT AT 30 Mc
 235 WATTS CW OUTPUT AT 470 Mc
 INTEGRAL RADIATOR

Full Ratings at Frequencies up to 500 Mc

GENERAL DATA

Electrical:

Heater, for Unipotential Cathode:

Voltage (AC or DC) ^a	13.5 ± 10%	volts
Current at 13.5 volts	1.3	amp
Minimum heating time.	60	sec

Mu-Factor, Grid No.2 to Grid No.1

for plate volts = 450, grid No.2 volts = 325, plate amperes = 1.2. . .	12
---------------------------------------------------------------------------	----

Direct Interelectrode Capacitances:^b

Grid No.1 to plate.	0.13 max.	μf
Grid No.1 to cathode.	16	μf
Plate to cathode.	0.011	μf
Grid No.1 to grid No.2.	22	μf
Grid No.2 to plate.	6.5	μf
Grid No.2 to cathode.	3.2	μf
Cathode to heater	3.4	μf

Mechanical:

Operating Position.	Any
Maximum Overall Length.	2.196"
Seated Length	1.850" ± 0.065"
Diameter.	1.426" ± 0.010"
Weight (Approx.).	3 oz
Socket.	Mycalex ^c No.CP464-2, or equivalent
Base.	Large-Wafer Elevenar 11-Pin with Ring (JEDEC No.E11-81)

Terminal Connections (See *Dimensional Outline*):

BOTTOM VIEW

Pin 1 - Cathode	Pin 10 - Grid No.2
Pin 2 - Grid No.2	Pin 11 - Grid No.1
Pin 3 - Grid No.1	RADIATOR - Plate
Pin 4 - Cathode	Terminal
Pin 5 - Heater	RING ^d - Grid-No.2
Pin 6 - Heater	Terminal
Pin 7 - Grid No.2	Contact
Pin 8 - Grid No.1	Surface
Pin 9 - Cathode	

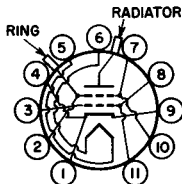

Thermal:

Terminal Temperature (All terminals).	250 max.	°C
Radiator Core Temperature (See <i>Dimensional Outline</i>)	250 max.	°C

Air Flow:

See accompanying *Typical Cooling Requirements* curve.



LINEAR RF POWER AMPLIFIER

Single-Sideband Suppressed-Carrier Service

Peak envelope conditions for a signal having
a minimum peak-to-average power ratio of 2

Maximum CCS Ratings, Absolute-Maximum Values:

	Up to 500 Mc		
DC PLATE VOLTAGE.	2200	max.	volts
DC GRID-No.2 VOLTAGE.	400	max.	volts
DC GRID-No.1 VOLTAGE.	-100	max.	volts
DC PLATE CURRENT AT PEAK OF ENVELOPE.	450 ^e	max.	ma
DC GRID-No.1 CURRENT.	100	max.	ma
PLATE DISSIPATION	150	max.	watts
GRID-No.2 DISSIPATION	8	max.	watts
PEAK HEATER-CATHODE VOLTAGE:			
Heater negative with			
respect to cathode.	150	max.	volts
Heater positive with			
respect to cathode.	150	max.	volts

Typical CCS Operation with "Two-Tone Modulation":

	At 30 Mc		
DC Plate Voltage.	1000	1500	volts
DC Grid-No.2 Voltage ^f	250	250	volts
DC Grid-No.1 Voltage ^f	-20	-20	volts
Zero-Signal DC Plate Current.	100	100	ma
Effective RF Load Resistance.	2270	3800	ohms
DC Plate Current:			
Peak of envelope.	210	210	ma
Average	160	160	ma
DC Grid-No.2 Current:			
Peak of envelope.	10	10	ma
Average	7	7	ma
Average DC Grid-No.1 Current.	0.05 ^g	0.05 ^g	ma
Peak-of-Envelope Driver Power			
Output (Approx.) ^h	0.3	0.3	watt
Output-Circuit Efficiency (Approx.) .	90	85	%
Distortion Products Level: ^j			
Third order	35	35	db
Fifth order	40	40	db
Useful Power Output (Approx.):			
Peak of envelope.	110 ^k	170 ^k	watts
Average	55 ^k	85 ^k	watts

Maximum Circuit Values:

Grid-No.1-Circuit Resistance			
under any condition:			
With fixed bias	25000	max.	ohms
With fixed bias (In Class AB ₁			
operation).	100000	max.	ohms
With cathode bias	Not recommended		
Grid-No.2-Circuit Impedance	10000	max.	ohms
Plate-Circuit Impedance	■		



RF POWER AMPLIFIER & OSCILLATOR — Class C Telegraphy
and
RF POWER AMPLIFIER — Class C FM Telephony

Maximum CCS Ratings, Absolute-Maximum Values:

	<i>Up to 500 Mc</i>	
DC PLATE VOLTAGE.	2200 max.	volts
DC GRID-No.2 VOLTAGE.	400 max.	volts
DC GRID-No.1 VOLTAGE.	-100 max.	volts
DC PLATE CURRENT.	300 max.	ma
DC GRID-No.1 CURRENT.	100 max.	ma
GRID-No.2 DISSIPATION.	8 max.	watts
PLATE DISSIPATION.	150 max.	watts
PEAK HEATER-CATHODE VOLTAGE:		
Heater negative with respect to cathode.	150 max.	volts
Heater positive with respect to cathode.	150 max.	volts

Typical CCS Operation:

In grid-drive circuit at frequency of

	<i>50</i>			<i>470</i>			<i>Mc</i>
DC Plate Voltage.	700	1000	1500	700	1000	1500	volts
DC Grid-No.2 Voltage	175	200	200	200	200	200	volts
DC Grid-No.1 Voltage	-10	-30	-30	-30	-30	-30	volts
DC Plate Current.	300	300	300	300	300	300	ma
DC Grid-No.2 Current	25	20	20	10	10	5	ma
DC Grid-No.1 Current	50	40	40	30	30	30	ma
Driver Power Output (Approx.) ^a .	1.2	2	2	5	5	5	watts
Useful Power Output.	120 ^k	175 ^k	275 ^k	100 ^p	165 ^p	235 ^p	watts

Maximum Circuit Values:

Grid-No.1-Circuit Resistance

under any condition:

With fixed bias 25000 max. ohms

Grid-No.2-Circuit Impedance 10000 max. ohms

Plate-Circuit Impedance ■

^a Because the cathode is subjected to back bombardment as the frequency is increased with resultant increase in temperature, the heater voltage should, for optimum life, be reduced to a value such that at the heater voltage obtained at minimum supply voltage conditions (all other voltages constant) the tube performance just starts to show some degradation; e.g., at 470 Mc, heater volts = 12.5 (Approx.).

^b Measured with special shield adapter.

^c Mycalex Corporation of America, 125 Clifton Boulevard, Clifton, New Jersey.

^d For use at higher frequencies.



- ^e The maximum rating for a signal having a minimum peak-to-average power ratio less than 2, such as is obtained in "Single-Tone" operation, is 300 ma. During short periods of circuit adjustment under "Single-Tone" conditions, the average plate current may be as high as 450 ma.
- ^f Obtained preferably from a separate, well regulated source.
- ^g This value represents the approximate grid-No.1 current obtained due to initial electron velocities and contact-potential effects when grid No.1 is driven to zero volts at maximum signal.
- ^h Driver power output represents circuit losses and is the actual power measured at input to grid-No.1 circuit. The actual power required depends on the operating frequency and the circuit used. The tube driving power is approximately zero watts.
- ^j with maximum signal output used as a reference, and without the use of feedback to enhance linearity.
- ^k This value of useful power is measured at load of output circuit.
- ^m The tube should see an effective plate supply impedance which limits the peak current through the tube under surge conditions to 15 amperes.
- ⁿ Driver power output includes circuit losses and is the actual power measured at the input to the grid circuit. It will vary depending upon the frequency of operation and the circuit used.
- ^p Measured in a typical coaxial-cavity circuit.

CHARACTERISTICS RANGE VALUES

Test No.	Note	Min.	Max.	
1. Heater Current	1	1.15	1.45	amp
2. Direct Interelectrode Capacitances:	2			
Grid No.1 to plate . .	-	-	0.13	μf
Grid No.1 to cathode .	-	14.3	17.7	μf
Plate to cathode . . .	-	0.0065	0.0155	μf
Grid No.1 to grid No.2.	-	19.8	24.2	μf
Grid No.2 to plate . .	-	5.7	7.1	μf
Grid No.2 to cathode .	-	2.6	3.6	μf
Cathode to heater. . .	-	2.5	4.1	μf
3. Grid-No.1 Voltage. . . .	1,3	-8	-19	volts
4. Reverse Grid-No.1 Current.	1,3	-	-25	μa
5. Grid-No.2 Current. . . .	1,3	-7	+6	ma
6. Peak Emission.	1,4	13	-	peak amp
7. Interelectrode Leakage Resistance	5	1	-	megohm

Note 1: With 13.5 volts ac or dc on heater.

Note 2: Measured with special shield adapter.

Note 3: With dc plate voltage at 700 volts, dc grid-No.2 voltage of 250 volts, and dc grid-No.1 voltage adjusted to give a dc plate current of 185 ma.

Note 4: For conditions with grid No.1, grid No.2, and plate tied together; and pulse voltage source connected between plate and cathode. Pulse duration is 2.5 microseconds and pulse repetition frequency is 60 pps. The voltage-pulse amplitude is 200 volts peak. After 1 minute at this value, the current-pulse amplitude will not be less than the value specified.

Note 5: Under conditions with tube at 20^o to 30^o C for at least 30 minutes without any voltages applied to the tube. The minimum resistance between any two electrodes as measured with a 200-volt Megger-type ohmmeter having an internal impedance of 1 megohm, will be 1 megohm.



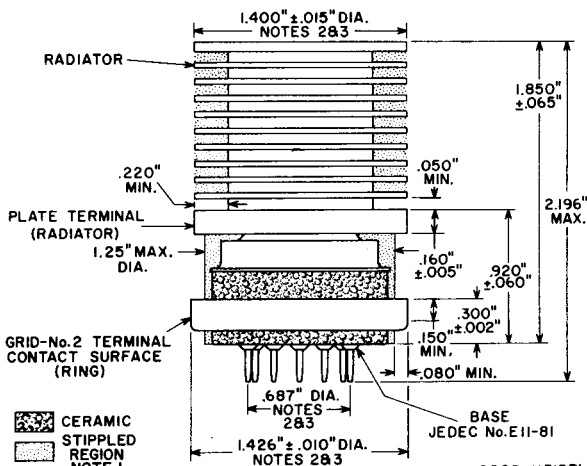

NOTE 1: KEEP ALL STIPPLED REGIONS CLEAR. DO NOT ALLOW CONTACTS OR CIRCUIT COMPONENTS TO PROTRUDE INTO THESE ANNULAR VOLUMES.

NOTE 2: THE DIAMETERS OF THE RADIATOR, GRID-No. 2 TERMINAL CONTACT SURFACE, AND PIN CIRCLE TO BE CONCENTRIC WITHIN THE FOLLOWING VALUES OF MAXIMUM FULL INDICATOR READING:

Radiator to Grid-No. 2

Terminal Contact Surface. 0.030" max.

Radiator to Pin Circle. 0.040" max.

Grid-No. 2 Terminal Contact

Surface to Pin Circle 0.030" max.

NOTE 3: THE FULL INDICATOR READING IS THE MAXIMUM DEVIATION IN RADIAL POSITION OF A SURFACE WHEN THE TUBE IS COMPLETELY ROTATED ABOUT THE CENTER OF THE REFERENCE SURFACE. IT IS A MEASURE OF THE TOTAL EFFECT OF RUN-OUT AND ELLIPTICITY.



TYPICAL COOLING REQUIREMENTS

AIR FLOW DIRECTED THROUGH
RADIATOR FROM 1-1/2" DIA.
ORIFICE LOCATED 1-1/2" FROM RADIATOR.
PLATE CORE TEMPERATURE—250° C.
INCOMING-AIR TEMPERATURE—24° C.

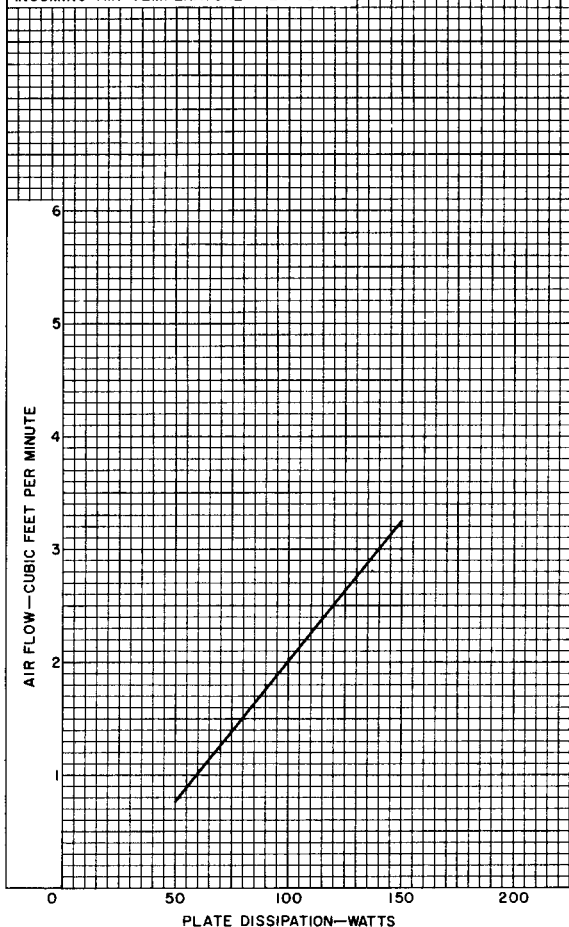

92CM-11298



TYPICAL PLATE CHARACTERISTICS

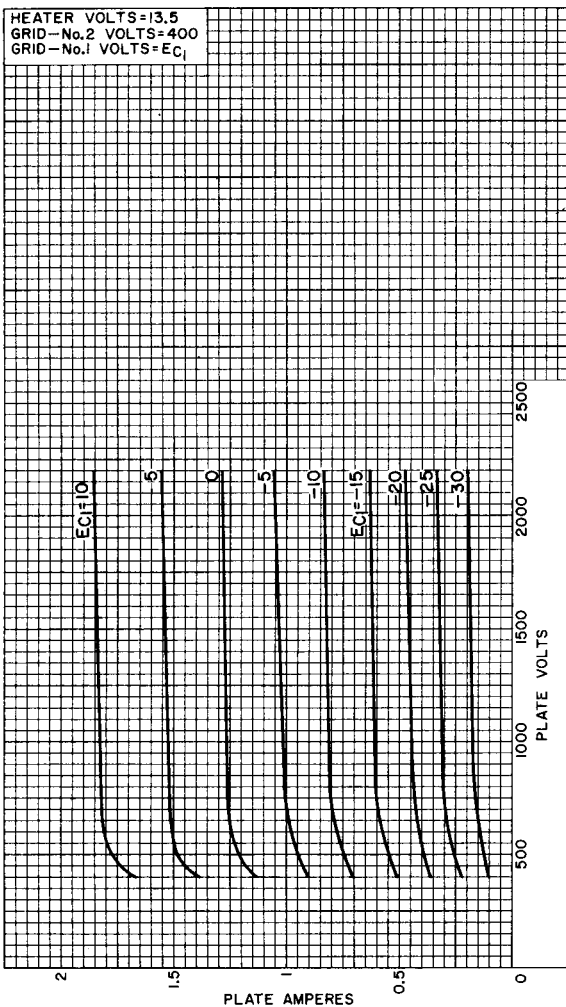

92CM-11290



TYPICAL PLATE CHARACTERISTICS

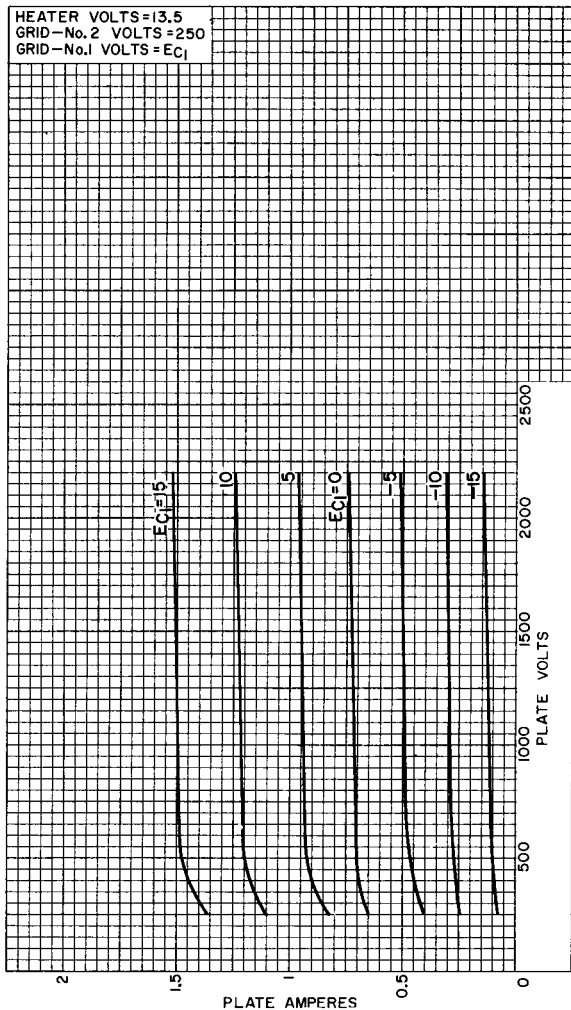

92CM-11288



TYPICAL PLATE CHARACTERISTICS

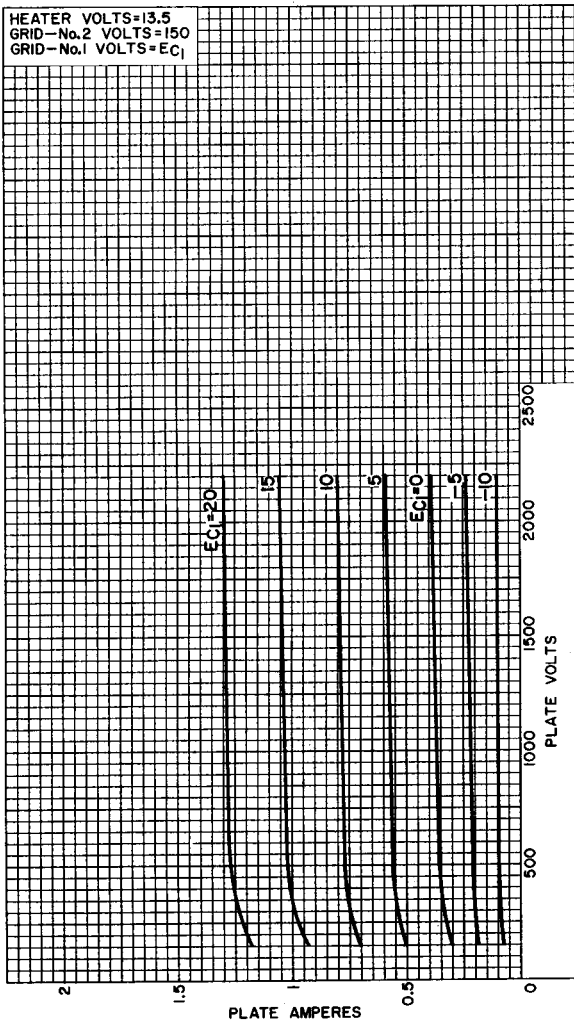

92CM-11289



TYPICAL CHARACTERISTICS

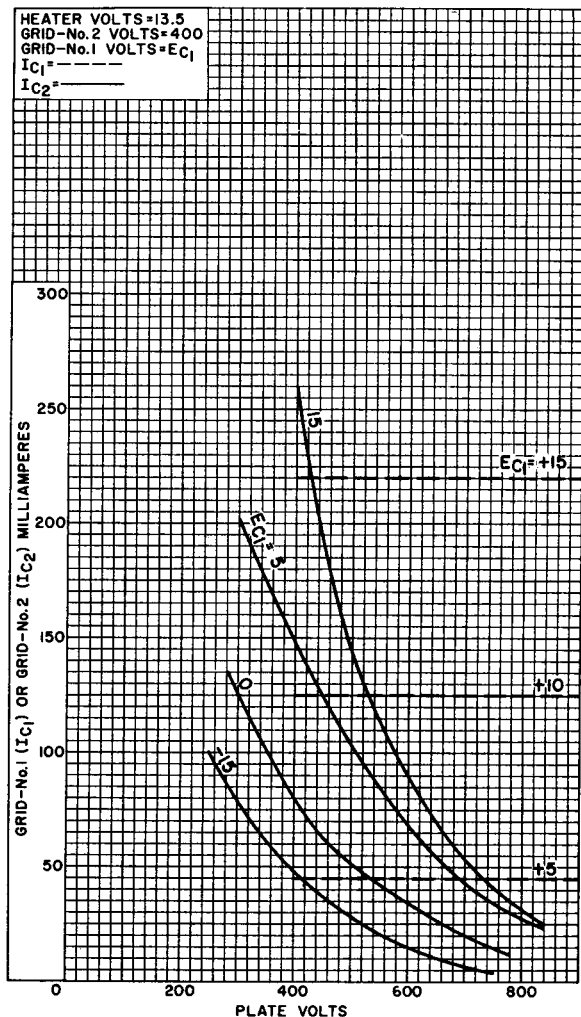

92CM-11293RI



TYPICAL CHARACTERISTICS

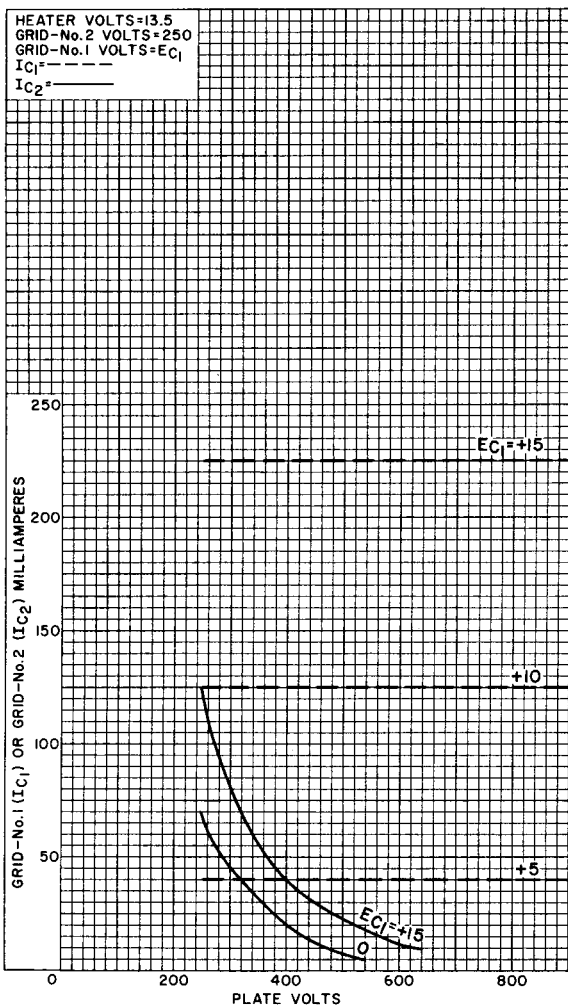

92CM-11291



TYPICAL CHARACTERISTICS

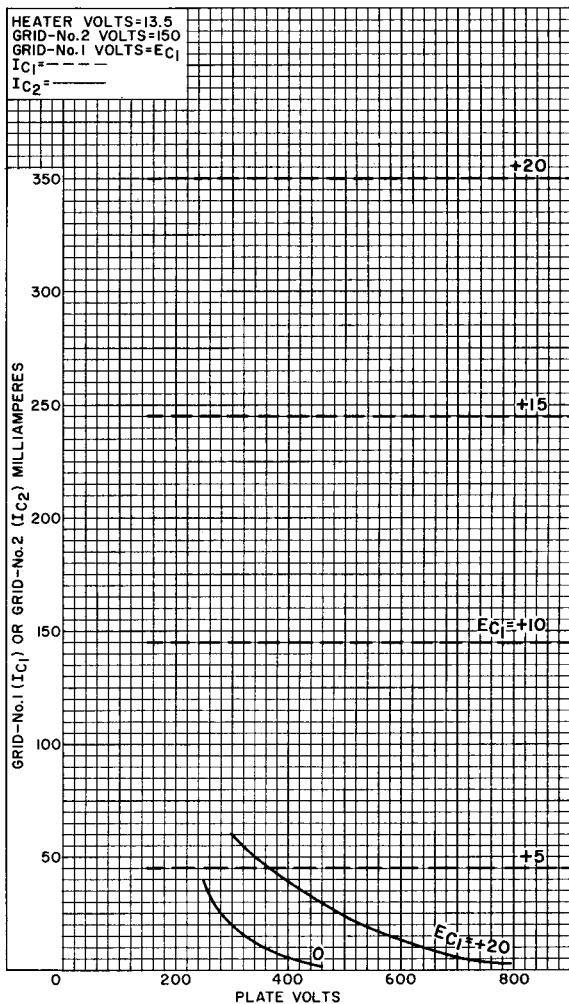

92CM-11292

